

RT-MINI II

A Self-flashing PV Mount Featuring Roof Tech's AlphaSeal™ Technology



- ✓ Less Aluminum
- ✓ More Efficient Design
- ✓ Additional Mounting Options
- ✓ Metal, EPDM, TPO, & Asphalt Roofs



RT-MINI II is suitable for all systems with a conventional L-Foot.

1/4" x 1" Carriage Bolt EMT Accessory

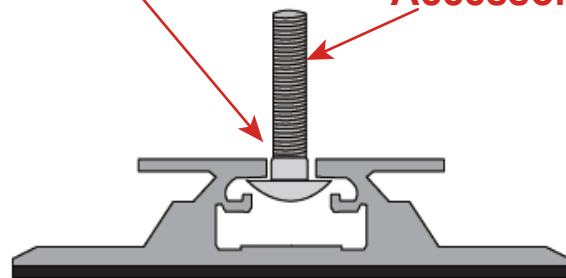

RT Serrated Hex Flange Bolt/Nut:
5/16-18 x 1"

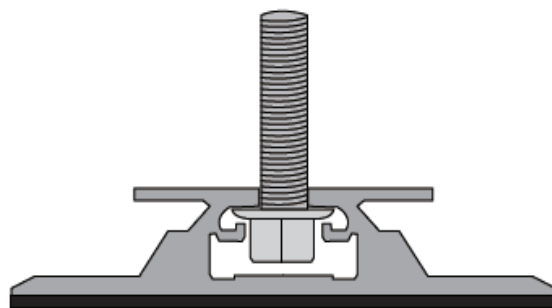

Installation Manual



ICC ESR 3575

Roof Tech

The Standard for Waterproof Flexible Flashing Since 1994

www.roof-tech.us

info@roof-tech.us

RT-MINI II

Flexible Flashing Certified by the International Code Council (ICC)

Components

RT2-00-MINIBK2



MINI II base : 20 ea.
Screw : 40 ea.
Extra RT-Butyl : 5 ea.

Optional Items:

5 x 60mm Mounting Screw (RT2-04-SD5-60) : 100 ea./Bag
5/16 X 25MM Flange Bolt & Nut (RT2-04-FBN25) : 100 ea./Bag
RT-Butyl (RT2-04-MNBUTYL) : 10 ea./Box

Dimensions in (mm)

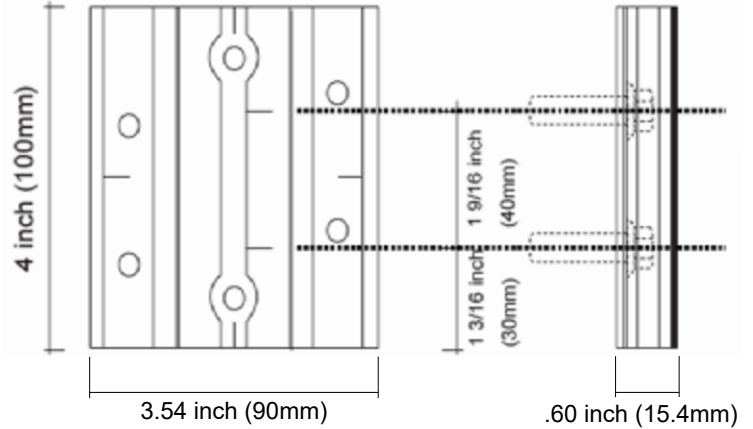

Deck Installation

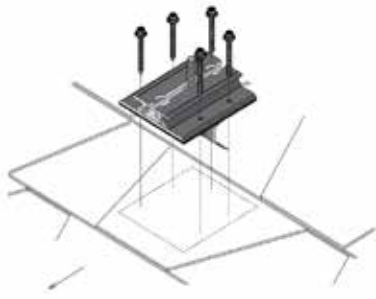

Rafter Installation

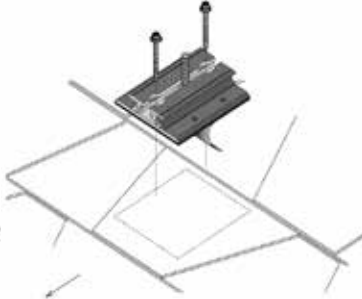

Offset Rafter Installation

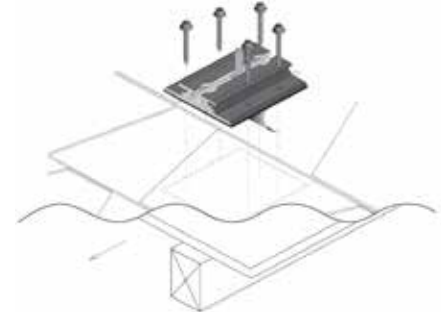

RT-Butyl is Roof Tech's flexible flashing used in one million residential PV systems for the last 27 years. It is the first PV mounting system with Flexible Flashing certified by the ICC. Engineered to withstand wind speeds up to 180 mph and ground snow up to 90 psf.

Engineered to ASTM D 1761

(Standard Test Methods for Mechanical Fasteners in Wood)

ICC ESR-3575

ASTM2140 Testing



TAS 100 A on metal and asphalt roof.

P.E. Stamped Letters available at www.roof-tech.us/support

Offset Rafter Attachment Options

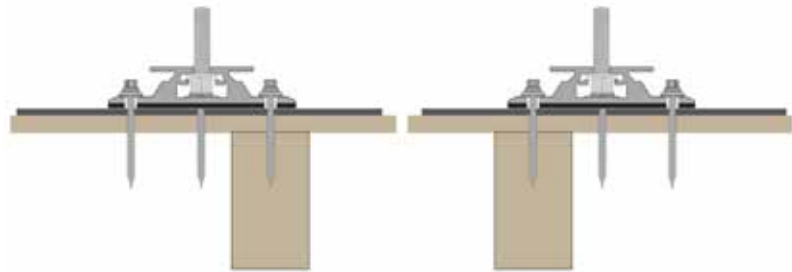

Metal Flashing Retrofit

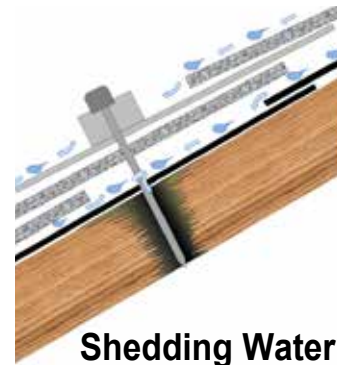

Shedding Water?

Flexible Flashing



100% Waterproof

Roof Tech Inc.

www.roof-tech.us

info@roof-tech.us

10620 Trenea Street, Suite 230, San Diego, CA 92131

858.935.6064